

# MASTERVOLT

THE POWER TO BE INDEPENDENT

## MPPT Solar ChargeMaster 25

BATTERY SOLAR CHARGE REGULATOR



### USER AND INSTALLATION MANUAL

1000009291/02



- (NL) Ga om deze handleiding in andere talen te downloaden naar onze website:
- (DE) Um diese Anleitung in anderen Sprachen herunterzuladen, besuchen Sie bitte unsere Website:
- (FR) Pour télécharger ce manuel dans d'autres langues, consultez notre site Web :
- (ES) Para descargar este manual en otros idiomas, visite nuestro sitio web:
- (IT) Per scaricare questo manuale in altre lingue, visitare la pagina del prodotto sul nostro sito Web:

[www.mastervolt.com](http://www.mastervolt.com)

## OVERVIEW

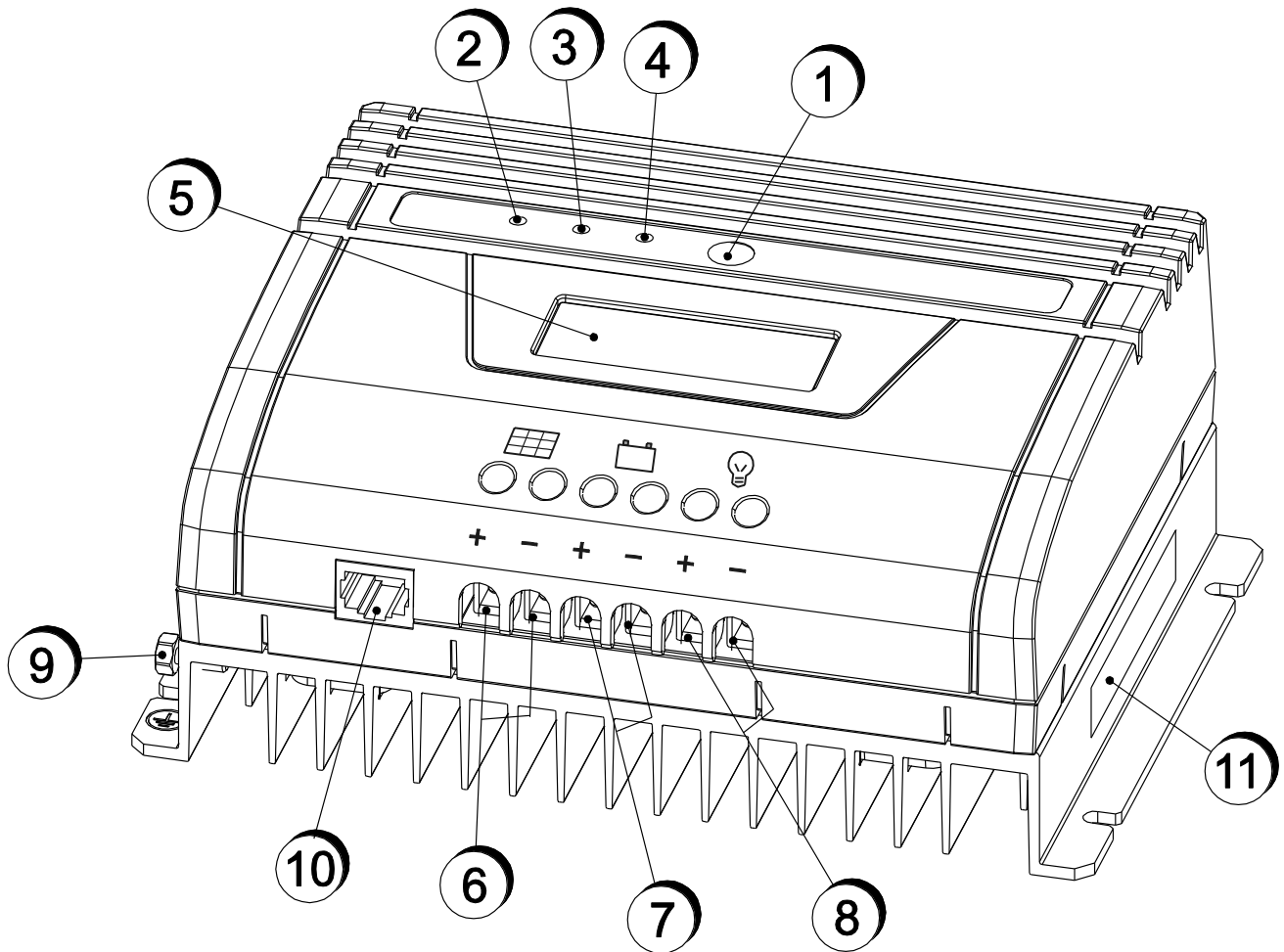

1. Power switch (Section 3.5)
2. Solar indicator LED (Section 3.6)
3. Charge indicator LED (Section 3.6)
4. Fault indicator LED (Section 3.6)
5. LCD-display (Section 3.6)
6. PV input
7. Battery connection
8. Load output
9. Grounding terminal
10. Temperature sensor jack
11. Identification label (Section 2.7)

Figure 1: Overview

**TABLE OF CONTENTS:**

<b>1</b>	<b>IMPORTANT SAFETY INSTRUCTIONS .....</b>	<b>4</b>
1.1	General .....	4
1.2	Explosive gases .....	4
1.3	Warnings regarding the use of batteries.....	4
1.4	Warning regarding life support applications .....	4
<b>2</b>	<b>GENERAL INFORMATION.....</b>	<b>5</b>
2.1	Use of this manual.....	5
2.2	Liability .....	5
2.3	Warranty.....	5
2.4	Disclaimer.....	5
2.5	Correct disposal of this product .....	5
2.6	Use of pictograms .....	5
2.7	Identification label.....	5
<b>3</b>	<b>OPERATION .....</b>	<b>6</b>
3.1	General .....	6
3.2	Maintenance.....	6
3.3	Three Step charge algorithm .....	6
3.4	Overview .....	7
3.5	POWER switch.....	7
3.6	LEDs and LCD display .....	8
<b>4</b>	<b>INSTALLATION .....</b>	<b>9</b>
4.1	Unpacking .....	9
4.2	Environment .....	9
4.3	Wiring and fuses.....	9
4.4	Specifications of the PV array .....	9
4.5	Connection of loads.....	10
4.6	Things you need.....	12
4.7	Connection .....	12
4.8	Commissioning after installation.....	14
4.9	Use in combination with Mastervolt MLI battery .....	15
4.10	Software version.....	16
4.11	Decommissioning .....	16
4.12	Storage and transportation .....	16
4.13	Re-installation.....	16
<b>5</b>	<b>TROUBLE SHOOTING .....</b>	<b>17</b>
<b>6</b>	<b>TECHNICAL DATA.....</b>	<b>18</b>
6.1	Specifications .....	18
6.2	Dimensions.....	19

# 1 IMPORTANT SAFETY INSTRUCTIONS

## READ AND SAVE THESE INSTRUCTIONS



### WARNING!

Read the entire manual before using the Solar ChargeMaster. Keep this manual in a secure place.

This chapter describes important safety and operating instructions for use of a Solar ChargeMaster.

### 1.1 GENERAL

- 1 Before using the Solar ChargeMaster (**SCM**), read all instructions and cautionary markings on the SCM and the batteries.
- 2 To reduce the risk of electric shock – Do not expose the SCM to rain, snow, spray, moisture, excessive pollution and condensing circumstances. To reduce risk of fire hazard, do not cover or obstruct the ventilation openings. Do not install the SCM in a non-ventilated room, as overheating may result.
- 3 Use of an attachment or spare part not recommended or sold by Mastervolt may result in a risk of fire, electric shock, or injury to persons.
- 4 The SCM is designed to be permanently connected to a PV array and DC electrical system. Installation of, and work on the SCM, may be carried out only by a qualified and trained personnel, consistent with the locally applicable standards and regulations.
- 5 Make sure that all wiring is properly installed and in good electrical condition; and that wire sizes are large enough for the ampere ratings of the SCM. Check the wiring on a regular base, at least once a year. Do not use the SCM when the wiring is undersized or damaged.
- 6 Do not operate the SCM if it has received a sharp blow, been dropped, or otherwise damaged in any way; take it to a qualified serviceman.
- 7 Except for the connection compartment, the SCM may not be opened or disassembled. There are no serviceable parts inside the cabinet. Take it to a qualified, authorized and trained serviceman when service or repair is required. Incorrect reassembly may result in a risk of electric shock or fire.
- 8 Two primary energy sources are present: a PV array and batteries. To reduce risk of electric shock, disconnect the SCM from both energy sources before attempting any maintenance or cleaning. Turning off controls will not reduce this risk.
- 9 This appliance is not intended for use by persons (including children) with reduced physical, sensory or mental capabilities, or lack of experience and knowledge, unless they have been given supervision or instruction concerning use of the appliance by a person responsible for their safety.
- 10 When the PV array is exposed to light, it supplies a DC voltage to the SCM which can be dangerous to touch. For this reason, use of an external DC-switch is strongly recommended. Alternatively, before attempting any maintenance or cleaning the PV-array should be protected from light exposure, e.g. by covering the PV modules.
- 11 The SCM is provided with a grounding terminal. Grounding and all other wiring must comply with local codes and ordinances.
- 12 Short circuiting or reversing polarity will lead to serious damage to batteries, SCM, wiring as well as accessories. Fuses cannot prevent damage caused by reversed polarity and the warranty will be void.
- 13 In case of fire, you must use the fire extinguisher which is appropriate for electrical equipment.
- 14 If applied in a marine application in the United States, external connections to the SCM shall comply with the United States Coast Guard Electrical Regulations (33CFR183, Sub part I).

### 1.2 EXPLOSIVE GASES

- 1 TO REDUCE RISK OF BATTERY EXPLOSION, FOLLOW THESE INSTRUCTIONS AND THOSE PUBLISHED BY BATTERY MANUFACTURER AND MANUFACTURER OF ANY EQUIPMENT YOU INTEND TO USE IN VICINITY OF THE BATTERY. REVIEW CAUTIONARY MARKING ON THESE PRODUCTS.
- 2 DANGER: To reduce the risk of explosion – Never use the SCM in situations where there is danger of gas or dust explosion or in areas in which ignition-protected equipment is required.

### 1.3 WARNINGS REGARDING THE USE OF BATTERIES

- 1 Consider having someone close enough by to come to your aid when you work near a lead-acid battery.
- 2 Have plenty of fresh water and soap nearby in case battery acid contacts skin, clothing, or eyes.
- 3 Wear complete eye protection and clothing protection. Avoid touching eyes while working near battery.
- 4 If battery acid contacts skin or clothing, wash immediately with soap and water. If acid enters eye, immediately flood eye with running cold water for at least 10 minutes and get medical attention immediately.
- 5 NEVER smoke or allow a spark or flame in vicinity of battery or engine.
- 6 Be extra cautious to reduce risk of dropping a metal tool onto battery. It might spark or short-circuit battery or other electrical part that may cause explosion.
- 7 Do not wear watches, bracelets, necklaces or other metal objects when working on batteries.
- 8 Only use SCM for charging a LEAD-ACID or Mastervolt MLI batteries and the supply of users attached to these batteries, in permanent systems. Do not use SCM for charging dry-cell batteries that are commonly used with home appliances.
- 9 NEVER charge a frozen battery.
- 10 Excessive battery discharge and/or high charging voltages can cause serious damage to batteries. Do not exceed the recommended limits of discharge level of your batteries.
- 11 If it is necessary to remove a battery, always remove grounded terminal from battery first. Make sure all accessories are off, so as not to cause an arc.
- 12 Be sure that the area around battery is well ventilated while battery is being charged. Refer to the recommendations of the battery manufacturer.
- 13 Batteries are heavy and may become a projectile if involved in an accident! Ensure adequate and secure mounting and always use suitable handling equipment for transportation.

### 1.4 WARNING REGARDING LIFE SUPPORT APPLICATIONS

Mastervolt products are not designed to be used as component of medical equipment, unless negotiated in the form of a written agreement between customer and/or manufacturer and Mastervolt. Such agreement will require the equipment manufacturer either to contract additional reliability testing of the Mastervolt parts and/or to commit to undertake such testing as a part of the manufacturing process. Furthermore, the manufacturer must agree to indemnify and not hold Mastervolt responsible for any claims arising from the use of the Mastervolt parts in the life support equipment.

## 2 GENERAL INFORMATION

### 2.1 USE OF THIS MANUAL

This manual serves as a guideline for the safe and effective operation, maintenance and possible correction of minor malfunctions of the Solar ChargeMaster 25. This manual is only valid for the following model:

Part number	Model
131902500	MPPT Solar ChargeMaster 25

This model is further referred to as “Solar ChargeMaster”. All the specifications, provisions and instructions contained in this manual apply solely to standard versions of the Solar ChargeMaster delivered by Mastervolt.

### 2.2 LIABILITY

Mastervolt can accept no liability for:

- Consequential damage resulting from the use of the Solar ChargeMaster.
- Possible errors in the included manual and the consequences of these.
- Use that is inconsistent with the purpose of the product.

### 2.3 WARRANTY

The Mastervolt product warranty covers the Solar ChargeMaster for the first two years after the purchase date, on the condition that the product is installed and used according to the instructions in this manual.

Installation or use that do not comply with these instructions may result in under performance, damage or failure of the product and may void this warranty. The warranty is limited to the cost of repair and/or replacement of the product. Costs of labor or shipping are not covered by this warranty.

### 2.4 DISCLAIMER

Our products are subject to continual development and improvement. Therefore, additions or modifications to the products may cause changes to the technical data and functional specifications. No rights can be derived from this document. Please consult our most current Terms & Conditions of Sale.

### 2.5 CORRECT DISPOSAL OF THIS PRODUCT

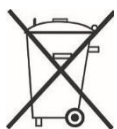

This product is designed and manufactured with high quality materials and components, which can be recycled and reused. Dispose of according to WEEE.

Act according to your local rules and do not dispose of your old products with your normal household waste. The correct disposal of your old product will help prevent potential

negative consequences to the environment and human health.

### 2.6 USE OF PICTOGRAMS

Safety instructions and warnings are marked in this manual and on the product by the following pictograms:



#### CAUTION!

Special information, commands and prohibitions in order to prevent damage.



#### WARNING

A WARNING refers to possible injury to the user or installer or significant material damage to the Solar ChargeMaster if the installer / user does not (carefully) follow the stated procedures.



Read this manual before installation and use.



This product has been declared conform the EC directives and standards.



Degree of protection: IP23. The product is protected against touch by fingers and water spray < 60 degrees from vertical.

### 2.7 IDENTIFICATION LABEL

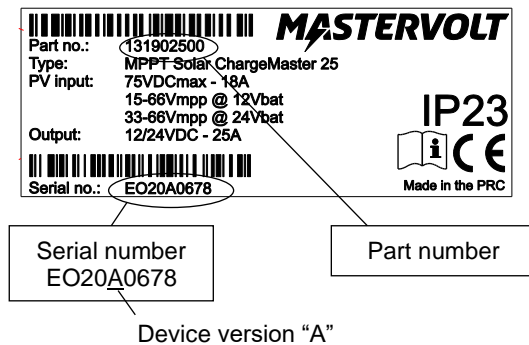

Figure 2: Identification label

The identification label is located at the right-hand side of the Solar ChargeMaster (see Figure 1). Important technical information required for service, maintenance & secondary delivery of parts can be derived from the identification label.



#### CAUTION!

Never remove the identification label. This will void the warranty.

## 3 OPERATION

### 3.1 GENERAL

The Mastervolt Solar ChargeMaster is a fully automatic battery charger which converts power from photovoltaic (PV) array to a regulated battery voltage. The PV array connected to the Solar ChargeMaster is operated at its optimum voltage to obtain an optimal yield (Maximum Power Point tracking). The Solar ChargeMaster will automatically adjust itself to a 12V or a 24V system. Under normal circumstances the Solar ChargeMaster remains switched on with the PV-array and batteries connected.

When power from the PV array is enough, the Solar ChargeMaster will initiate the charging process.



#### WARNING

The Solar ChargeMaster has no on/off switch. Charging will be initiated as soon as power from the PV-array becomes available.

The Solar ChargeMaster is protected against overload, short circuit, overheating and under and over voltage.



#### CAUTION!

The Solar ChargeMaster is not protected against:

- Excessive overvoltage on the Solar input;
- Surges inducted by lightning.

### 3.2 MAINTENANCE

No specific maintenance to the Solar ChargeMaster is required. Examine your electrical installation on a regular base, at least once a year. Defects such as loose connections, damaged wiring etc. must be corrected immediately.

If necessary, use a soft clean cloth to clean the casing of the Solar ChargeMaster. Do not use any liquids or corrosive substances, such as solvents, alcohol, petrol or abrasive components.

In the event of decommissioning, refer to section 4.11

### 3.3 THREE STEP CHARGE ALGORITHM

See Figure 3. Battery charging is accomplished in three automatic stages: BULK, ABSORPTION and FLOAT.

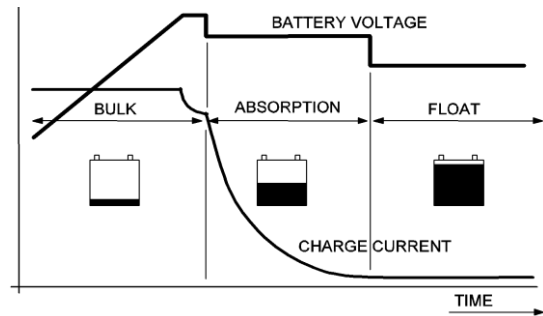

Figure 3: Three step charge system

- **BULK:** At this stage the charger delivers its maximum current for quick charging from 0 to 80%.
- **ABSORPTION:** The charger has reached its maximum charge voltage and the charge current will slowly decrease until the battery is charged up to 100%.
- **FLOAT:** This stage begins once the battery is fully charged. The battery remains in fully charged state.

By installing the battery temperature sensor, the charge voltages are automatically adapted for deviating temperatures.

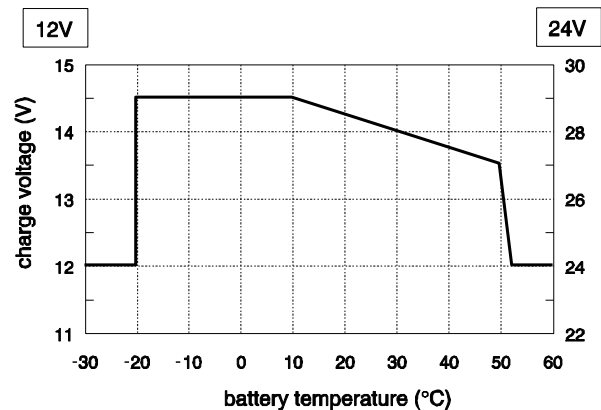

Figure 4: Temperature compensated charging

See Figure 4. When the battery temperature is low, the charge voltage increases. On the other hand, when the battery temperature is high, the charge voltage is decreased. Overcharge and gassing are prevented this way. This will extend the life of your batteries.

3.4 OVERVIEW

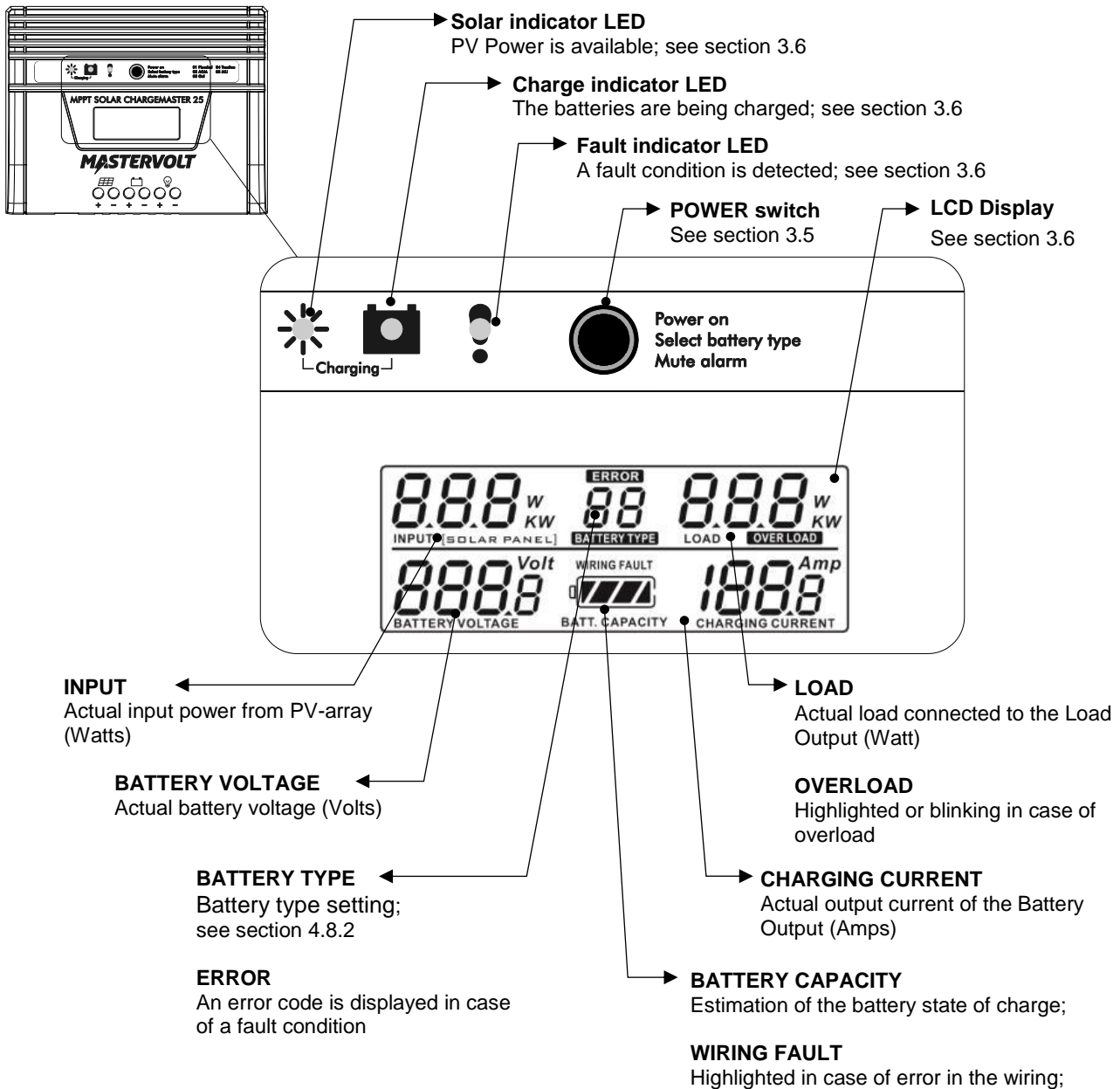





Figure 5: Operation of the Solar ChargeMaster

3.5 POWER SWITCH

POWER switch operation	Meaning
Press shortly	Activate LCD-display (see text below)
1 second	Switch on Solar ChargeMaster again after a fault or error situation
1 second	Mute audible alarm
>5 seconds	Battery type setting, see section 4.8.2

## 3.6 LEDES AND LCD DISPLAY

LED indication			LCD indication	Audible alarm*	Meaning
					
Blue	Green	(Off)	--	(Off)	Normal operation, batteries are being charged.
(Off)	(Off)	(Off)	(Off)	(Off)	Irradiation on the PV modules is insufficient (for instance during night time). The Solar ChargeMaster is in sleep mode to reduce power drain from the batteries. The display can be activated temporarily by pressing the POWER switch shortly. The display will be deactivated automatically after 1 minute.
(Off)	(Off)	(Off)	(Off)	(Off)	No power from the PV-modules. Check wiring to PV-modules if the Solar ChargeMaster is switched off during daytime. Check for loose connections or incorrect polarity.
(Off)	(Off)	Yellow	--	(Off)	Reversed polarity on the PV-input. Check PV array wiring.
(Off)	(Off)	Red	--	(Off)	Reversed polarity on the Battery connection. Check battery wiring.
(Off)	(Off)	Orange	--	(Off)	Reversed polarity on the PV-input and Battery connection. Check wiring.
--	--	--	<b>OVERLOAD</b> blinking	Every 2 seconds	Overload on Load output (110%). Reduce connected load.
--	--	--	 blinking	Every second	Low battery voltage. Reduce load connected to the batteries and charge batteries.
--	--	--	F0	Continuously	Power from PV-modules is OK, but battery voltage too low (< 8.5V @ 12V / <17V @ 24V). Check batteries.
--	--	--	F1	Continuously	Overcharge, battery voltage is too high. The charger will automatically cut off output. Check batteries.
--	--	--	F2 + <b>OVERLOAD</b>	Continuously	Overload on Load output (130%). The charger will automatically cut off the output. Reduce connected load.
--	--	--	E1 + <b>ERROR</b>	Continuously	Voltage from PV-modules is too high. Check PV-array.
--	--	--	E2 + <b>ERROR</b>	(Off)	MLI Ultra battery only: <i>Stop charge event</i> generated. Refer to user's manual of the MLI Ultra battery.
--	--	--	E3 + <b>ERROR</b>	Continuously	Battery temperature too high. Check batteries.
--	--	--	E4 + <b>ERROR</b>	Continuously	Battery temperature too low. Check batteries.

\* The audible alarm can be muted by holding the POWER switch pressed for 1 second.

\*\* Refer to section 4.8.2 for battery type settings.



## 4 INSTALLATION

During installation, commissioning and maintenance of the Solar ChargeMaster, the Important Safety Instructions are applicable at all times.

### 4.1 UNPACKING

The delivery includes the following items:

- Solar ChargeMaster;
- Battery temperature sensor;
- Modular cable assembly (see section 4.9);
- This User's manual
- Important Safety Instructions

After unpacking, check the contents for possible damage. Do not use the product if it is damaged. If in doubt, contact your supplier.

### 4.2 ENVIRONMENT

Obey the following stipulations during installation:

- The Solar ChargeMaster is designed for indoor use only.
- Ambient operating temperature: -20°C ... 55°C / -4°F ... 131°F (power de-rating above 40°C / 104°F to decrease the internal temperature).
- Humidity: 5-95%, non-condensing.
- The Solar ChargeMaster must be mounted to a vertical, solid and heat-resistant surface, with the connecting cables downwards.
- Do not expose the Solar ChargeMaster to excessive dust, aggressive environments, ammonia or salt.
- Make sure that the hot air that is developed during operation can be discharged. The Solar ChargeMaster must be mounted in such a way that obstruction of the airflow along the heatsink on the backside of the casing will be prevented.
- The Solar ChargeMaster requires a minimum of 20 cm/8" of clearance on every side to ensure safety and proper ventilation.
- Do not locate the Solar ChargeMaster in the same compartment as the batteries.
- Do not install the Solar ChargeMaster straight above the batteries because of possible corrosive Sulphur fumes.
- Although the Solar ChargeMaster fully complies with all applicable EMC limits, it may still cause harmful interference to radio communication equipment. If such interference appears, it is recommended to increase the separation between the Solar ChargeMaster and the equipment, to relocate the receiving antenna or to connect the equipment to a circuit different from that to which the Solar ChargeMaster is connected.

### 4.3 WIRING AND FUSES



#### WARNING

The wire and fuse sizes stated in this manual are given as guideline only. Always comply with all local rules and regulations.

Keep in mind that high current will pass through the DC wiring. Keep the cable length as short as possible, this will keep the system efficiency as high as possible. The recommended minimum cross sections of the wiring are:

Connection	Minimum DC Cable cross section	
	<2m / 6ft length	2 - 4m / 6 - 12ft
PV input	6mm <sup>2</sup> / AWG10	10mm <sup>2</sup> / AWG8
Battery	6mm <sup>2</sup> / AWG10	10mm <sup>2</sup> / AWG8
Load	6mm <sup>2</sup> / AWG10	10mm <sup>2</sup> / AWG8

Use boot lace ferrules on the wire ends. These ferrules must be crimped with a proper crimping tool.

Use the following wire colors for DC wiring:

Wire color	Meaning	Connect to:
Red	Positive	+ (POS)
Black	Negative	- (NEG)

Lay the positive and negative cables next to each other to limit the electromagnetic field around the cables. The negative battery cable should be connected directly to the negative post of the battery bank or the ground side of a current shunt. Do not use the chassis frame as the negative conductor. Tighten securely. The positive battery cable must be fused and connected to the positive post of the battery bank.

The recommended DC fuses are:

Connection	DC fuse
Battery fuse	40A
Load fuse	40A

### 4.4 SPECIFICATIONS OF THE PV ARRAY



#### WARNING

When the PV array is exposed to light, it supplies a DC voltage to the Solar ChargeMaster which can be dangerous to touch. For this reason, use of an external DC-switch is strongly recommended. Alternatively, before attempting any maintenance or cleaning the PV-array should be protected from light exposure, e.g. by covering the PV modules.



#### CAUTION!

Do not connect Solar ChargeMasters in parallel on the side of the PV array.

The Solar ChargeMaster can be used with any PV array configuration that satisfies the following requirements:

- Maximum open circuit PV voltage: 75 V DC;
- The open circuit voltage from the PV array must be 5Volts higher than the battery voltage.



### CAUTION!

Never connect voltages higher than specified to the PV-input, as this will cause permanent damage to the Solar ChargeMaster.

Configuration examples for PV-arrays consisting of monocrystalline or polycrystalline PV-modules:

Battery voltage $U_{NOM} = 12V$		
Panel type	Number of panels	
	in series	parallel
36 cells	1 up to 3	Max. 360Wp
60 cells	1	Max. 360Wp
72 cells	1	Max. 360Wp

Battery voltage $U_{NOM} = 24V$		
Panel type	Number of panels	
	in series	parallel
36 cells	2 up to 3	Max. 720Wp
60 cells	1	Max. 720Wp
72 cells	1	Max. 720Wp

**Note:** The Solar ChargeMaster will automatically limit the input current and power to its specified rating (see section 6.1). Excess power will not be converted.

## 4.5 CONNECTION OF LOADS

Depending on the energy system in which the Solar ChargeMaster is used, there are two options to connect the electrical load to the Solar ChargeMaster:

- To the Load output on the Solar ChargeMaster, or
- Directly to the battery.

### 4.5.1 Load connected to the Load output

See Figure 6 for a typical installation diagram. The Load output is provided with a protection circuit that switches off the connected load automatically in case of overload or if the battery voltage is too low. This kind of installation is typically used when the PV-modules are the only source of electrical power to charge the battery.

Characteristics:

- Maximum DC-load: 25A
- Under voltage disconnect: 10.5V
- Under voltage reconnect: 11.0V

### 4.5.2 Load connected to the battery

If the maximum load will exceed 25 Amps or if the battery will also be charged by other energy sources, such as a battery charger or an alternator, the electrical load shall be connected to the battery directly. See Figure 7 for a typical installation diagram. In this situation the battery is no longer protected against too low battery voltages. Installation of additional undervoltage protection circuits may be necessary.

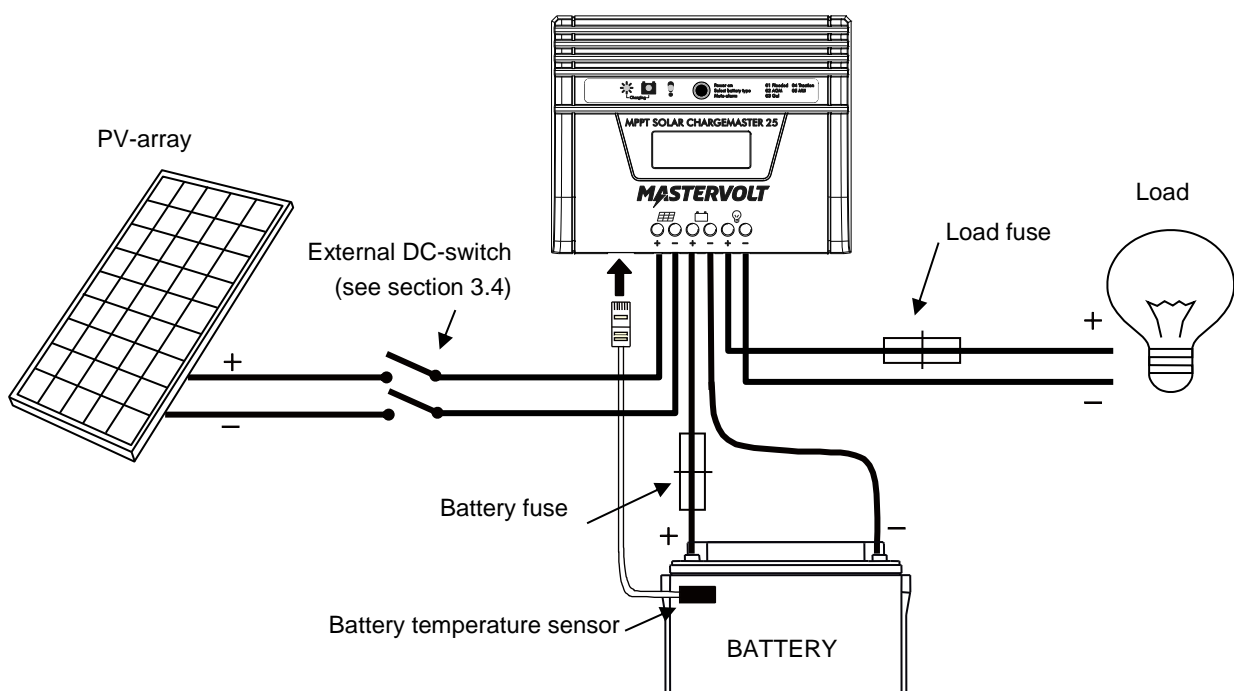

Figure 6: Load connected to the Load output on the Solar ChargeMaster

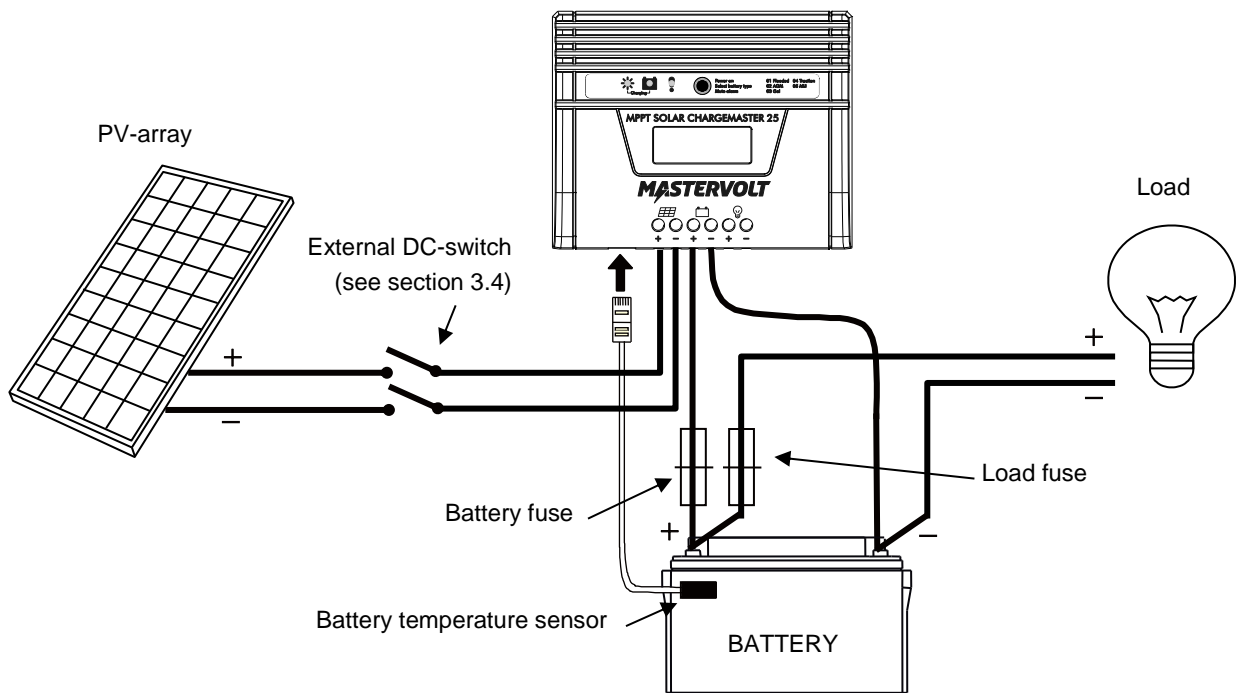

Figure 7: Load connected directly to the battery

Above schematics are to illustrate the general placement of the Solar ChargeMaster in a circuit. They are not meant to provide detailed wiring instructions for any particular electrical installation.

## 4.6 THINGS YOU NEED

Make sure you have all the parts you need to install the Solar ChargeMaster:

- Solar ChargeMaster (included);
- Battery temperature sensor with cable and plug (included);
- DC cables to connect the Solar ChargeMaster; see section 4.3 for specifications;
- DC-fuse holder with a DC-fuse, to be integrated in the positive DC-cable to the battery; see section 4.3.
- Screws / bolts (Ø 4mm max.) (with plugs) to mount the Solar ChargeMaster to a surface;
- Batteries;
- Appropriate and reliable cable terminals, strain reliefs, battery terminals and boot lace ferrules.

We recommend as a minimum tool kit:

- Phillips screw driver nr.2 or flat blade screw driver 5 mm to fix the DC-cables;
- Tools to fix the screws / bolts with plugs to mount the Solar ChargeMaster to a surface.

## 4.7 CONNECTION

### 4.7.1 General



#### WARNING

Let installation work be done by a licensed electrician.

All electrical systems must be disconnected from any power source during the entire installation!



#### CAUTION!

- Short circuiting or reversing DC polarity may lead to damage to the Solar ChargeMaster, the cabling and/or the terminal connections.
- Follow all steps of the installation instructions in order of succession as described.



#### CAUTION!

Too-thin cables and/or loose connections can cause dangerous overheating of the cables and/or terminals. Therefore, tighten all connections well, in order to limit transition resistance as far as possible. Use cables of the correct size. Use additional strain reliefs to prevent the transmission of stress to the screw connectors.



#### CAUTION!

The negative connections of the Solar ChargeMaster are common and therefore have the same electrical potential. If grounding is required, always do this on the negative wires. Use one grounding point only.

**Note:** If the battery temperature remains within 15-25°C, connection of the battery temperature sensor is optional.

4.7.2 Installation step by step

1 Mark the position of the four mounting spots. Then fix the casing to the wall.

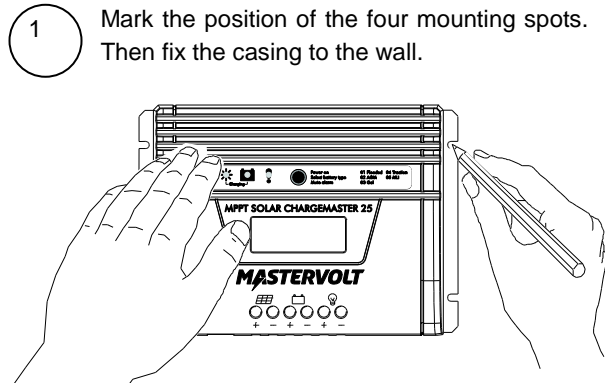

Figure 8

2 Fit boot lace ferrules to all DC-cables. Connect the wiring of the Load-output (see section 4.5). Integrate a fuse holder in the positive load wire, but do not place the fuse yet.

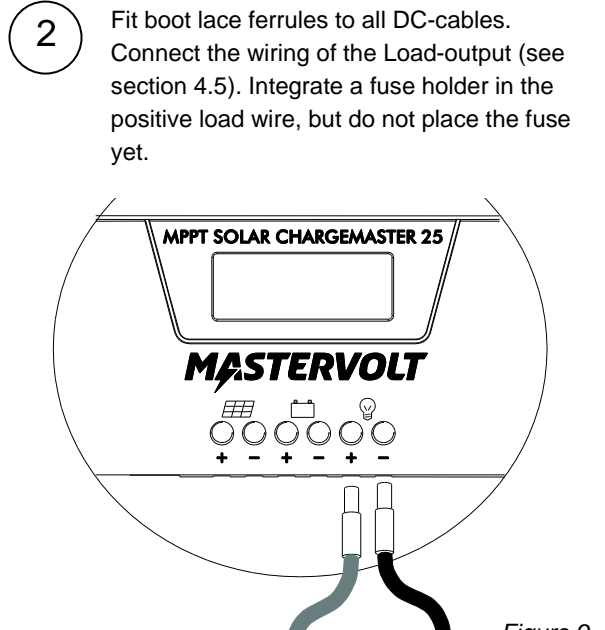

Figure 9

3 Connect the wiring to the battery. Integrate a fuse holder in the positive battery wire, but do not place the fuse yet.

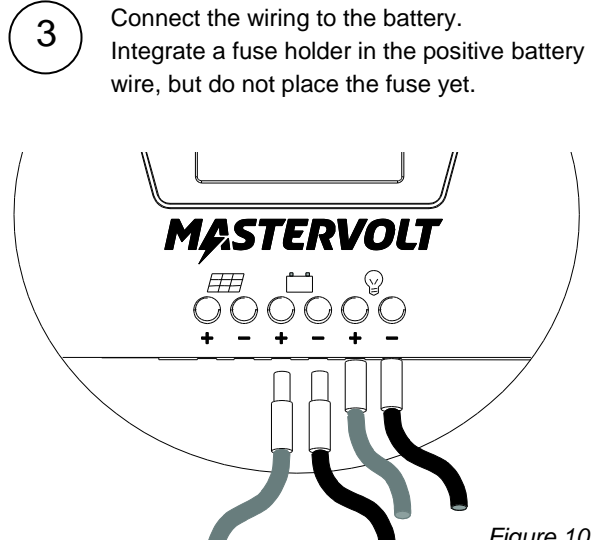

Figure 10

4 Attach the battery temperature sensor to the casing the battery. Plug the temperature sensor cable into the Temperature sensor jack.

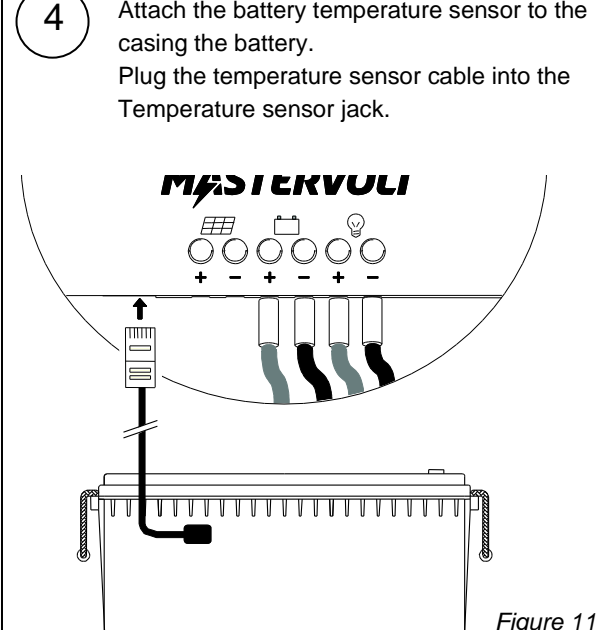

Figure 11

**WARNING**  
Risk of shock! When the PV array is exposed to light, it supplies a dangerous DC voltage. See section 4.4.

5 Connect the PV array

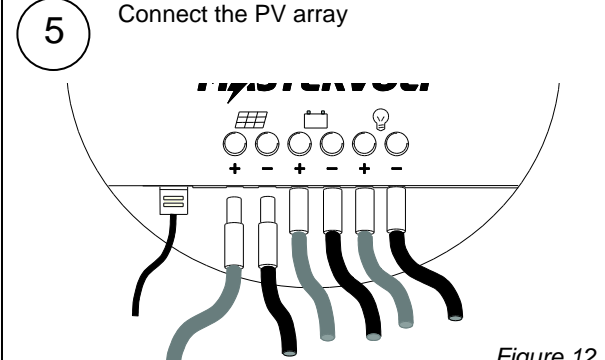

Figure 12

6 If grounding is required, connect the grounding terminal to the central grounding point of the electrical installation; see Figure 1, item 10. See also section 4.7.1

7 Check all wiring: positive to +, negative to -. See also Figures 6 and 7 for wiring examples. If OK, continue with section 4.8 for commissioning of the Solar ChargeMaster.

## 4.8 COMMISSIONING AFTER INSTALLATION

### 4.8.1 Commissioning step-by-step



#### CAUTION!

Check the polarity of all wiring before commissioning: positive connected to positive (red cables), negative connected to negative (black cables).

- 1 If all wiring is OK, place the DC-fuse between the Solar ChargeMaster and the load.
- 2 Then place the DC-fuse between the Solar ChargeMaster and the battery.



#### WARNING

When placing this fuse, a spark can occur, caused by the capacitors used in the Solar ChargeMaster. This is particularly dangerous in places with insufficient ventilation, due to the gassing of the batteries an explosion can occur. Avoid having flammable materials close by.

- 3 The Solar ChargeMaster will initiate the charging process if the voltage from the PV array is 5VDC higher than the battery voltage; see chapter 3.

**Note:** If the Solar ChargeMaster does not switch on, press the POWER switch for 1 second.

### 4.8.2 Battery type setting

The Solar ChargeMaster is suitable for charging the following battery types: Flooded lead acid, AGM, Spiral, Gel, Traction batteries and Mastervolt Li-Ion batteries (MLI).



#### WARNING

The MLI charging voltages on this charger fit the Mastervolt Li-ion (MLI) batteries but do not necessarily fit other Li-ion batteries! See also section 4.9. Always follow the instructions provided by the battery manufacturer!



#### CAUTION!

Invalid settings of the Solar ChargeMaster can cause serious damage to your batteries and/or the connected load! Adjustments of settings may be undertaken by authorised personnel only.

**Note:** If your Solar ChargeMaster is not new, you must consider that former users may have changed the settings.

The actual setting for Battery type is shown on the display during normal operation mode. See Figure 13.

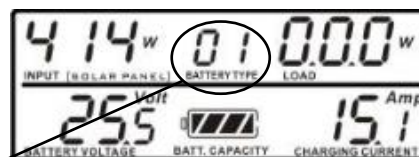

Indication	Battery type
01	Flooded
02	AGM
03	Gel
04	Traction
05	Mastervolt MLI (see section 4.9)

Figure 13: Battery type setting

To change the Battery type setting:

- Hold the POWER button (Figure 1) pressed until the Battery type indication starts blinking;
- Press the POWER button shortly to scroll through the Battery type settings as described above;
- Hold the POWER button pressed until the Battery type indication stops blinking to confirm the desired setting.

When the POWER button is not touched for 10 seconds, the Solar ChargeMaster will return to the normal operation mode without changing a setting.

#### 4.9 USE IN COMBINATION WITH MASTERVOLT MLI BATTERY

If the Solar ChargeMaster is used in combination with a Mastervolt MLI Ultra type Li-ion battery, charging is stopped if the MLI Ultra battery generates the *Stop charge event*.

Additional things you need:

- MasterBus Multipurpose Contact Output;
- Modular cable assembly (included in the delivery of the Solar ChargeMaster).

Follow next additional steps to install the Solar ChargeMaster in combination with a Mastervolt MLI type Li-ion battery (see Figure 14):

- 1 Do not use the battery temperature sensor. Instead plug the loose provided modular cable assembly into the Temperature sensor jack;
- 2 Connect the other side of this cable assembly to the Multipurpose Contact Output as indicated;

- 3 Connect the DC main wiring and other components as indicated;
- 4 Connect the MasterBus cabling between the devices as indicated;
- 5 Add a MasterBus control panel to the MasterBus network;
- 6 Configure the following *Stop Charge event* at the Li-ion battery:

Configuration	Event 1 (obligatory)
Event source	Stop Charge
Event target	INT DC Relay
Event command	Activate
Event data	Copy

- 7 Adjust setting for Battery type to Mastervolt MLI (see section 4.8.2);
- 8 Continue with the “Commissioning” section in the manual of the MLI Ultra battery.

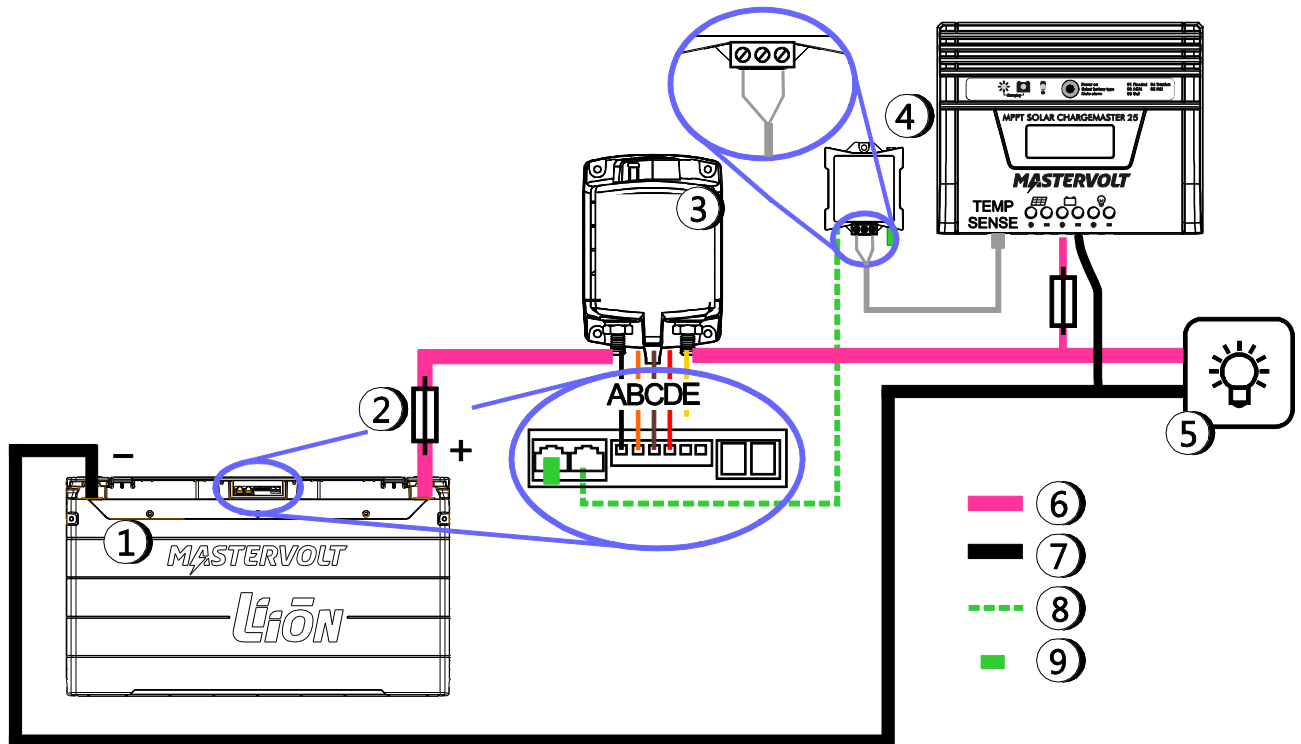

- |  |                        |
|--|------------------------|
| ① Li-ion battery   | ⑤ Loads                |
| ② Battery fuse in positive battery line  | ⑥ DC positive cable    |
| ③ Safety relay   | ⑦ DC negative cable    |
| ④ MasterBus Multipurpose Contact Output via modular cable assembly connected to the Solar ChargeMaster | ⑧ MasterBus cable      |
|  | ⑨ MasterBus terminator |

Figure 14: Use of the Solar ChargeMaster in combination with a Mastervolt MLI Ultra battery

#### 4.10 SOFTWARE VERSION

To check the version of the installed software:

- Hold the POWER button (Figure 1) pressed until the Battery type indication starts blinking;
- The version of the installed software is shown at the right upper side of the display (Figure 15);
- After 10 seconds the Solar ChargeMaster returns to the normal operation mode.

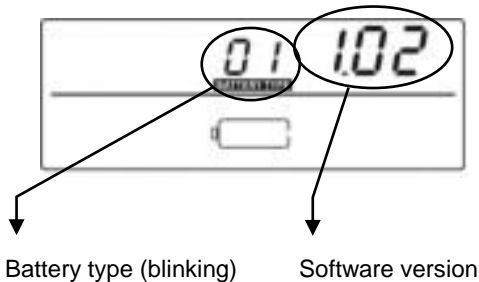

Figure 15: Software version

#### 4.11 DECOMMISSIONING

To put the Solar ChargeMaster out of operation, follow these instructions in order of succession:

- 1 Switch off all loads that are connected to the Solar ChargeMaster;
- 2 Disconnect the PV array by switching off the switch between the PV-array and the Solar ChargeMaster (or protect the PV-array from light exposure, e.g. by covering the PV modules);
- 3 Remove the DC-fuse between the Solar ChargeMaster and the battery;
- 4 Remove the DC-fuse between the Solar ChargeMaster and the load;
- 5 Check with a suitable voltage meter whether the Battery connection and the LOAD output of the Solar ChargeMaster are voltage free;
- 6 Disconnect the negative cable to the PV array from the terminal block of the Solar ChargeMaster. Isolate the core of the wire with insulating tape;
- 7 Do the same for the positive cable to the PV array;
- 8 Disconnect all other remaining wiring.

Now the Solar ChargeMaster can be demounted in a safe way.

#### 4.12 STORAGE AND TRANSPORTATION

When not installed, store the Solar ChargeMaster in the original packing, in a dry and dust free environment. Always use the original packing for transportation. Contact your local Mastervolt Service Centre for further details if you want to return the apparatus for repair.

#### 4.13 RE-INSTALLATION

To reinstall the Solar ChargeMaster, follow the instructions as described in this chapter (chapter 4).



## 5 TROUBLE SHOOTING

If you cannot solve a problem with the aid of this chapter, contact your local Mastervolt Service Centre. See [www.mastervolt.com/technical-support](http://www.mastervolt.com/technical-support). Make sure you have the following information present if you must contact your local Mastervolt Service Center to solve a problem:

- Article and serial number; see section 2.7.
- Software version; see section 4.10.

Malfunction	Possible cause	What to do
No output voltage and/or current	Solar ChargeMaster was switched off due to a previous fault situation	Press POWER-button for one second to switch on the Solar ChargeMaster again
	Check section 3.6 for an overview of fault indications of the LEDs and the LCD display	
Display shows <b>OVERLOAD</b> or error code E1, E2, E3, E4, F0, F1 or F2	Check section 3.6 for an overview of fault indications of the LEDs and the LCD display	
Fault indicator LED illuminated	Check section 3.6 for an overview of fault indications of the LEDs and the LCD display	
Audible alarm active	Press POWER switch for 1 second to mute the alarm. Check section 3.6 for an overview of fault indications of the LEDs and the LCD display	
No display	The Solar ChargeMaster is in sleep mode	Press the POWER switch shortly to activate the display
Output voltage too low, charger supplies maximum current	Load that is connected to the batteries is larger than charger can supply.	Reduce load taken from the batteries.
	Batteries not 100% charged	Measure battery voltage. After some time, this will be higher.
	Wrong battery type setting	Check settings (see section 4.8.2).
Charge current too low	Batteries almost fully charged	Nothing, this is normal when the battery is almost fully charged.
	High ambient temperature	Nothing; if ambient temperature is above 40°C / 104°F the charge current is automatically reduced.
	Low irradiation on the PV-array.	Check PV-array, check for shading.
Battery not fully charged	Current to load is too high	Reduce load taken from the batteries.
	Charge time too short	Use an additional battery charger
	Battery temperature too low	Use the battery temperature sensor.
	Defective or worn-out battery	Check battery and replace if necessary.
	Wrong battery type setting	Check settings (see section 4.8.2).
Battery is discharged too fast	Battery capacity reduced due to sulphation or due to plate corrosion	Charge and recharge a few times, this might help. Check battery and replace if necessary.
Batteries are too warm, gassing	Defective battery (short circuit in cell)	Check battery and replace if necessary.
	Battery temperature too high	Use the battery temperature sensor.
	Wrong battery type setting	Check settings (see section 4.8.2).

## 6 TECHNICAL DATA

### 6.1 SPECIFICATIONS

Model	MPPT Solar ChargeMaster 25	
Article no.	131902500	
Nominal battery voltage (U <sub>NOM</sub> )	12V and 24 V (Auto detection)	
<b>PV-INPUT</b>	<b>@ U<sub>NOM</sub> = 12V</b>	<b>@ U<sub>NOM</sub> = 24V</b>
Maximum connected PV power	360Wp	720Wp
Maximum input PV power*	300W	600W
Full power voltage MPPT range	15 V ~ 66 V	30 V ~ 66 V
Absolute maximum PV Voltage	75V <sub>DC</sub>	75V <sub>DC</sub>
MPP tracking	Yes, integrated MPP tracker	
Start-up voltage:	Battery voltage + 3V <sub>DC</sub>	
Maximum PV input current	18A <sub>DC</sub>	
EU efficiency	>97%	
Peak static power conversion efficiency	>98%	
Static MPPT efficiency	>99%	
<b>BATTERY OUTPUT</b>	<b>@ U<sub>NOM</sub> = 12V</b>	<b>@ U<sub>NOM</sub> = 24V</b>
Maximum charge current (I <sub>MAX</sub> )	25 A	25 A
Charge voltage, Absorption:	14.25V (Traction: 14.45V)	28.5V (Traction: 28.9V)
Charge voltage, Float;	13.25V (AGM, gel: 13.8V, MLI: 13.5V)	26.5V (AGM, gel: 27.6V, MLI: 27.0V)
Battery temperature compensation	-30 mV/°C	-60 mV/°C
DC consumption (at night):	5mA	5mA
DC consumption (on, no charging):	<110mA	<80mA
Charge algorithm:	Three step (Bulk, Absorption, Float)	
Battery types**:	Flooded, AGM, Gel, Traction, Mastervolt MLI.	
<b>LOAD OUTPUT</b>	<b>@ U<sub>NOM</sub> = 12V</b>	<b>@ U<sub>NOM</sub> = 24V</b>
Maximum output current	25 A, max 36A peak for 1 sec.	25 A, max 36A peak for 1 sec.
Under voltage disconnect	10.5V	21.0V
Under voltage reconnect	11.0V	22.0V
<b>GENERAL</b>		
Galvanic isolation between PV and battery	No, common negative conductor	
Dimensions in mm [inch] (h x w x d):	135 x 190 x 73 mm [5.3 x 7.5 x 2.9 inch]; see also section 6.2	
Weight:	1 kg	
Operating Temperature Range	-20°C ≤ T <sub>AMB</sub> ≤ +55°C [-4°F ≤ T <sub>AMB</sub> ≤ 131°F]	
Full Power Temperature range	-20°C ≤ T <sub>AMB</sub> ≤ +40°C [-4°F ≤ T <sub>AMB</sub> ≤ 104°F] (no power de-rating)	
Non-operating Temperature range	-40°C ≤ T <sub>AMB</sub> ≤ +75°C [-4°F ≤ T <sub>AMB</sub> ≤ 167°F] (storage temperature)	
Relative Humidity	5% to 95% non-condensing	
Protection degree	IP23	
MasterBus connectivity	No	
Terminals:	Screw terminals, max. wire size 10mm <sup>2</sup>	

\* Automatic limitation of input power; excessive power will not be converted

\*\* Refer to section 4.8.2 for battery type settings.

Specifications are subject to change without prior notice.

6.2 DIMENSIONS

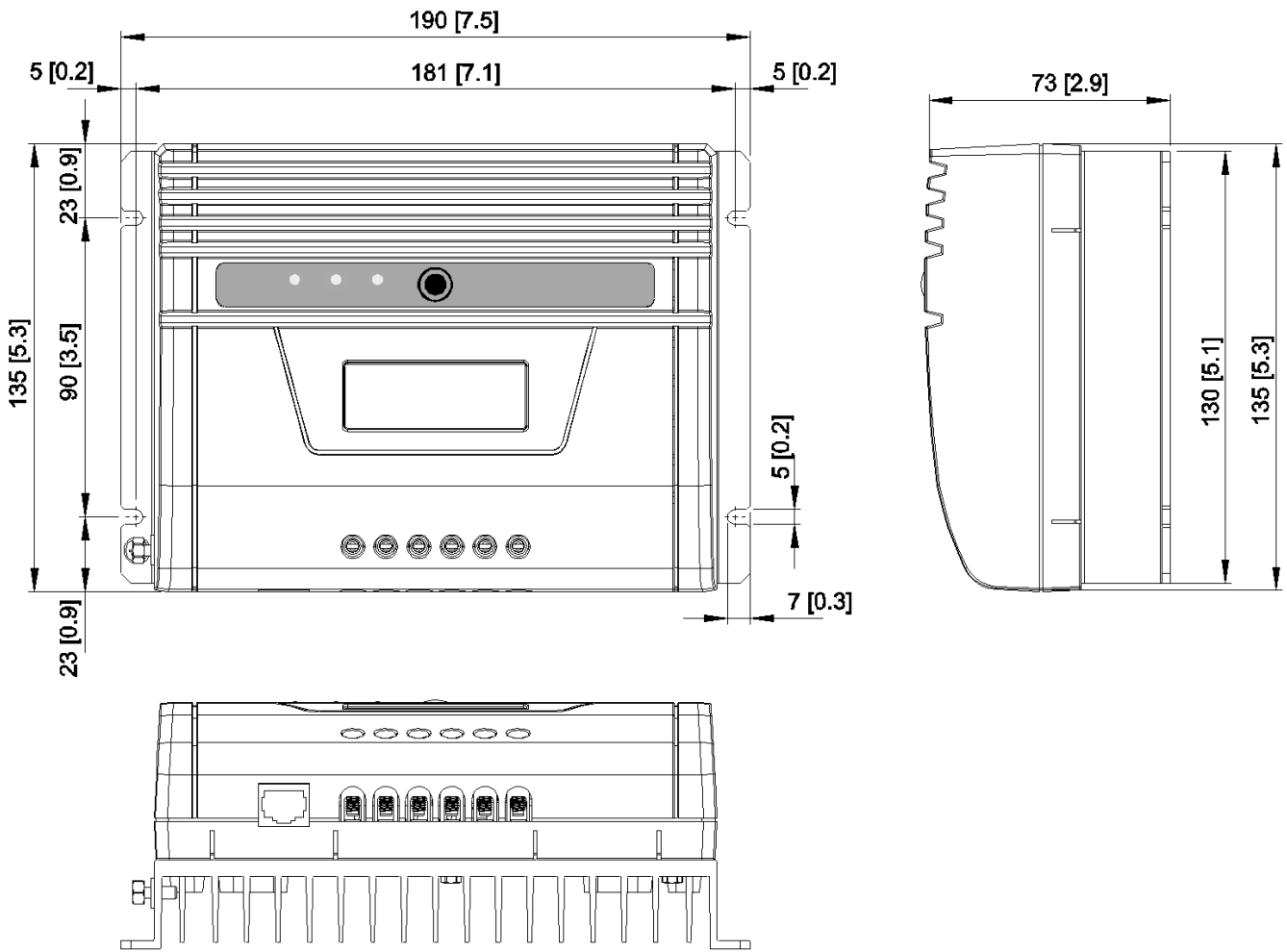

Figure 16: Dimensions of the Solar ChargeMaster in mm [inches]



**Europe, Middle East & Africa**

**Customer Service**

T: +31 (0) 20 34 22 100  
E: [info@mastervolt.com](mailto:info@mastervolt.com)

**Technical Support**

T: +31 (0) 20 34 22 100  
E: [ts@mastervolt.com](mailto:ts@mastervolt.com)

**Location & Shipping**

Mastervolt  
Snijdersbergweg 93  
1105 AN Amsterdam  
The Netherlands

**Americas & Caribbean**

**Customer Service**

T: +1 800 307 6702, Option 1  
E: [orderentry@marinco.com](mailto:orderentry@marinco.com)

**Technical Support**

T: +1 800 307 6702, Option 2  
E: [tsusa@mastervolt.com](mailto:tsusa@mastervolt.com)

**Location & Shipping**

Power Products, LLC  
N85 W12545 Westbrook Crossing  
Menomonee Falls, Wisconsin 53051  
United States

**Asia Pacific**

**Customer Service**

T: +64 9 415 7261 Option 1  
E: [enquiries@bepmarine.com](mailto:enquiries@bepmarine.com)

**Technical Support**

T: +64 9 415 7261 Option 3  
E: [technical@bepmarine.com](mailto:technical@bepmarine.com)

**Location & Shipping**

BEP Marine  
42 Apollo Drive  
Rosedale, Auckland 0632  
New Zealand